

Wind and Water – Better Together

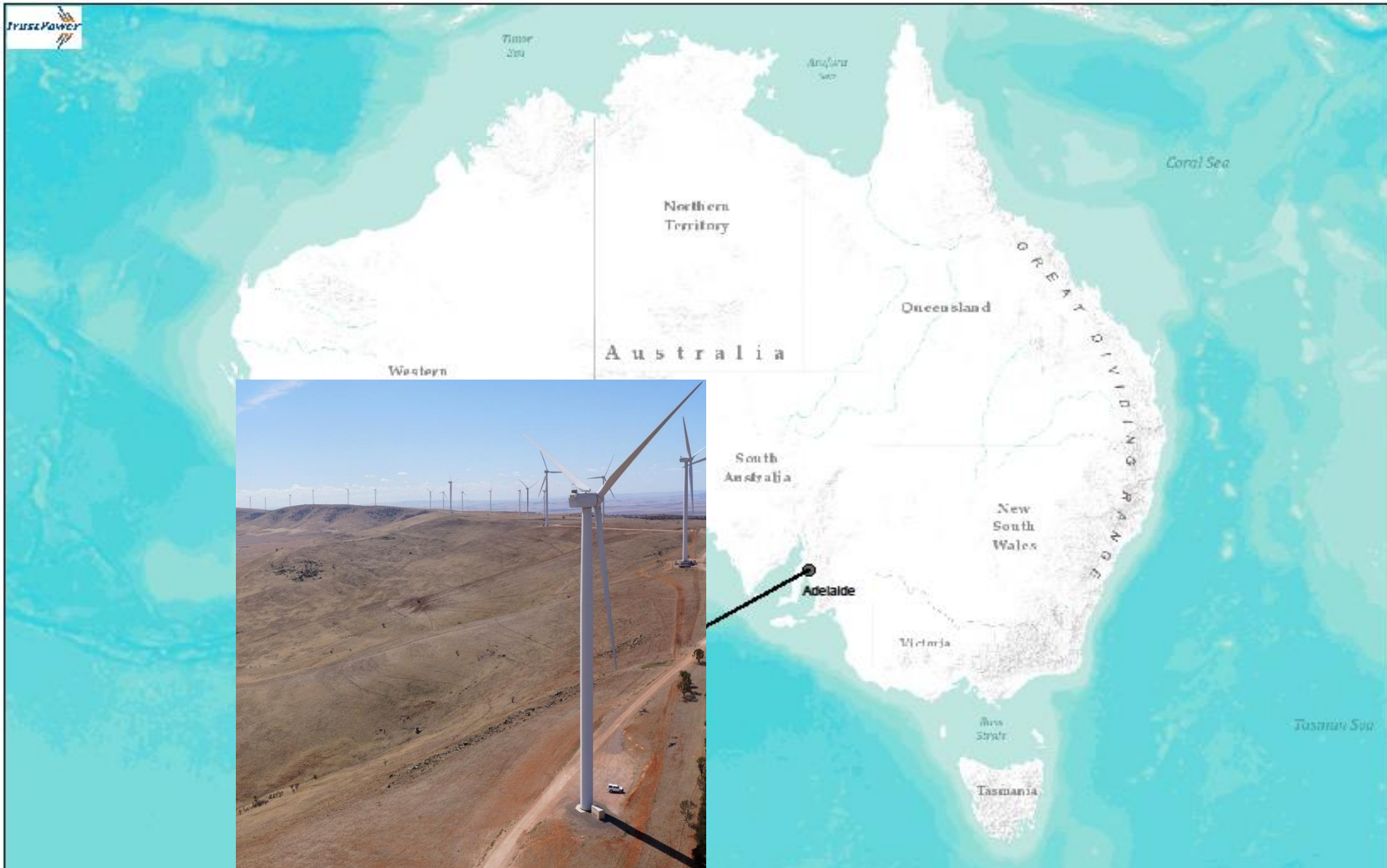

# West Island

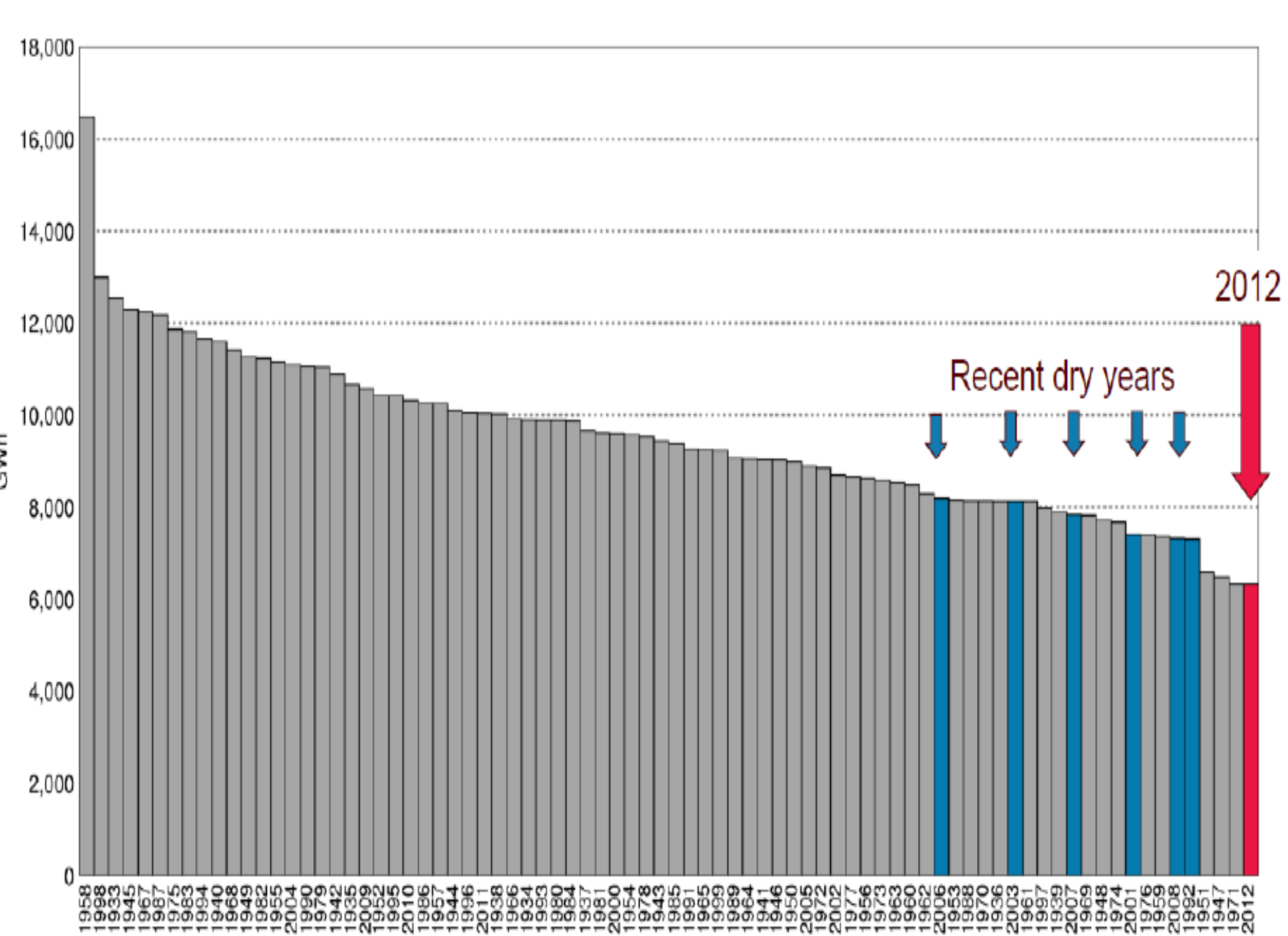





# GOOD DAY

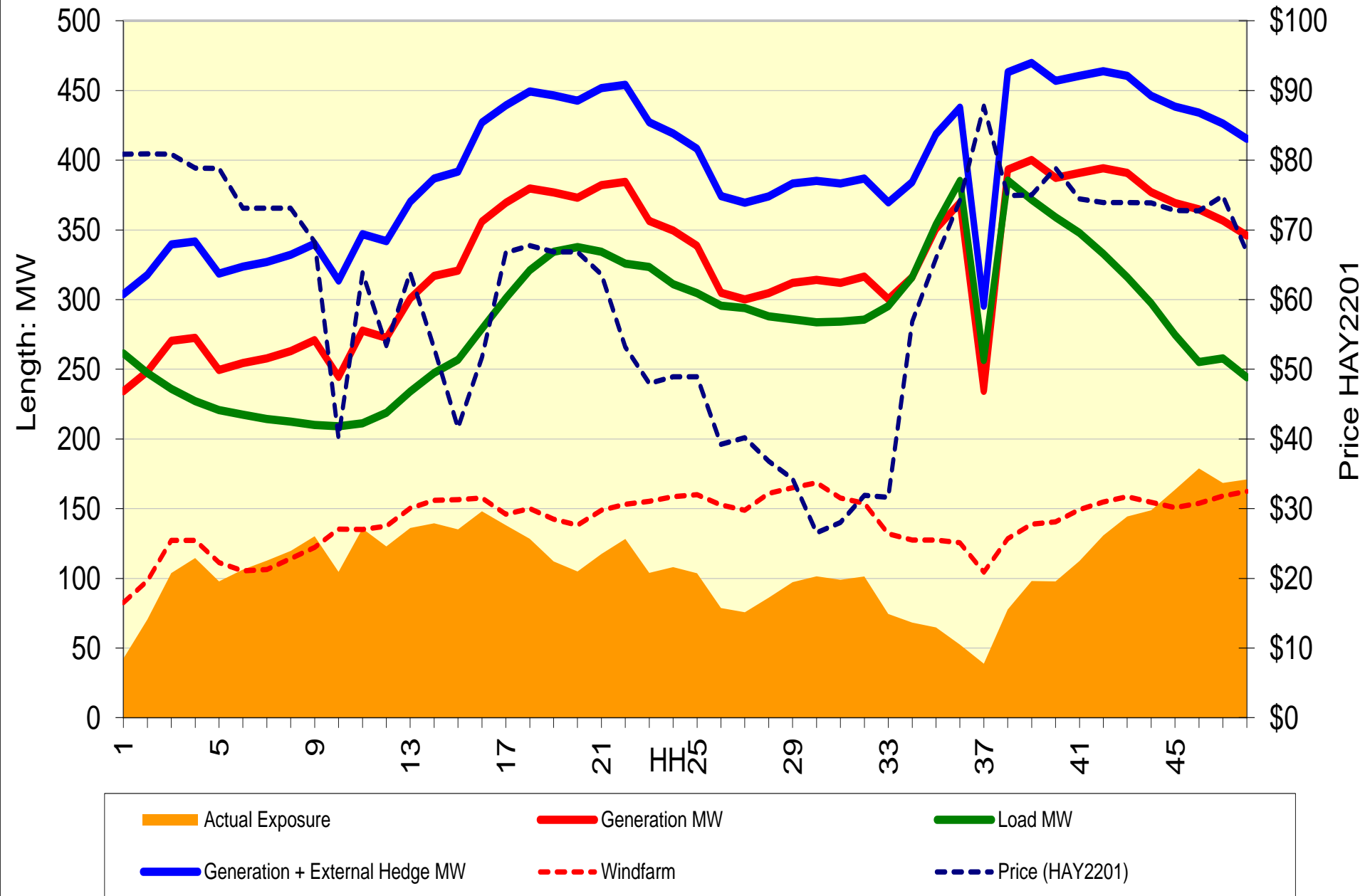

# NOT SO GOOD DAY

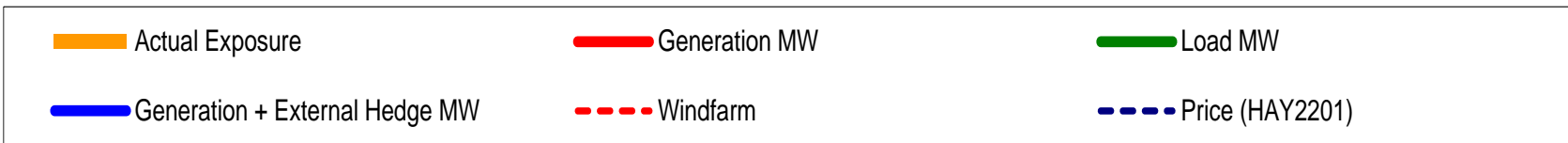
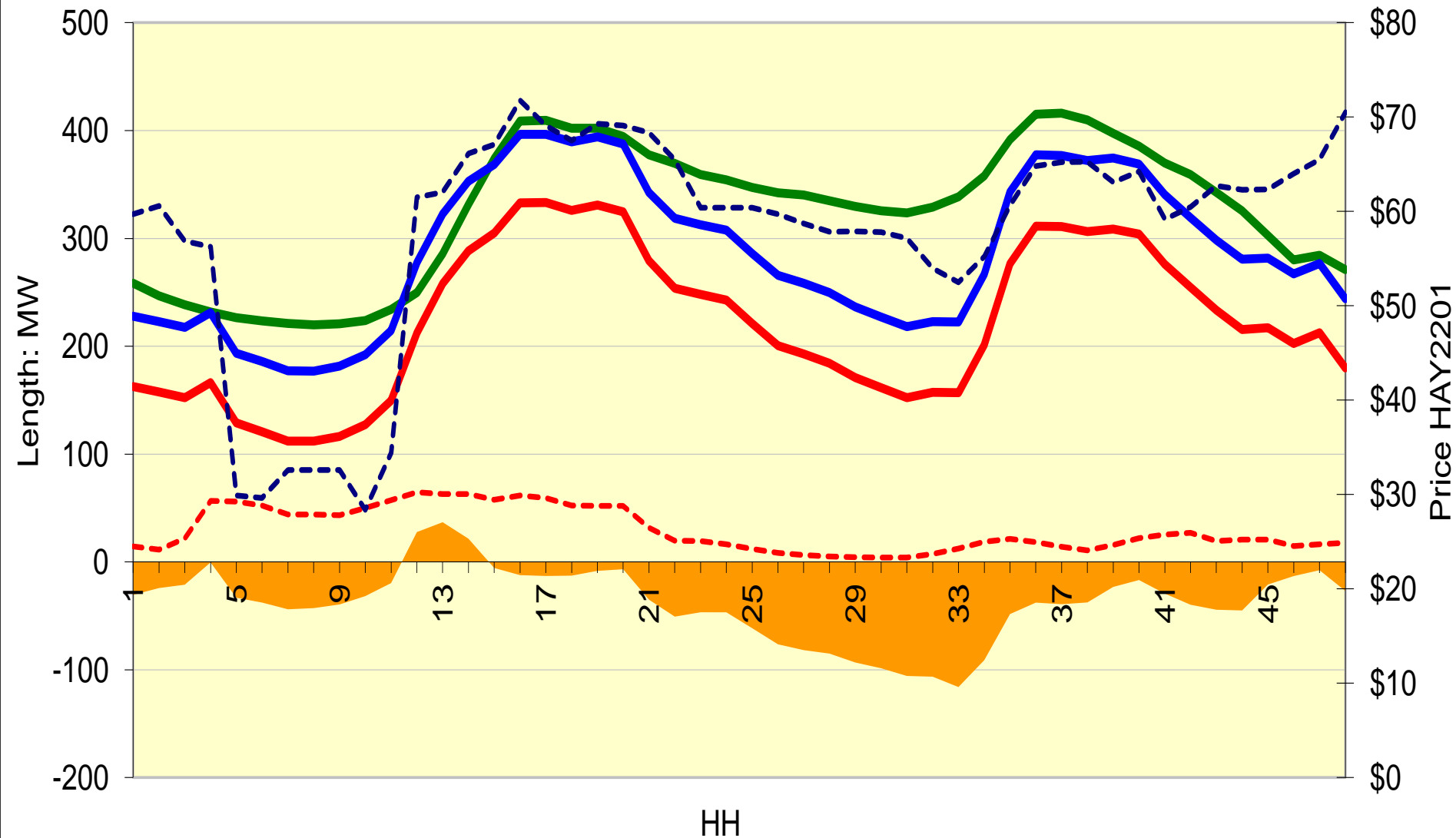

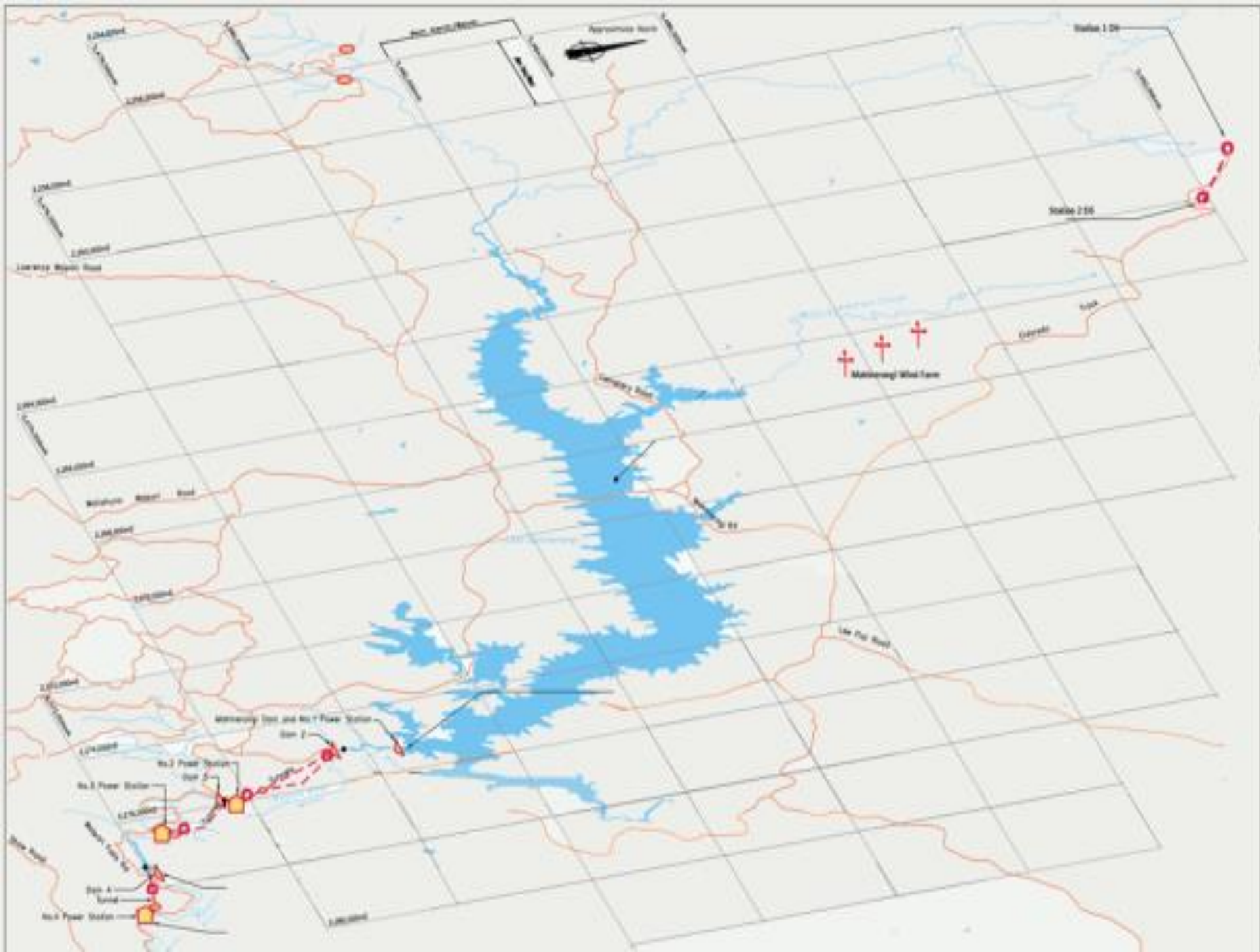



# National Grid

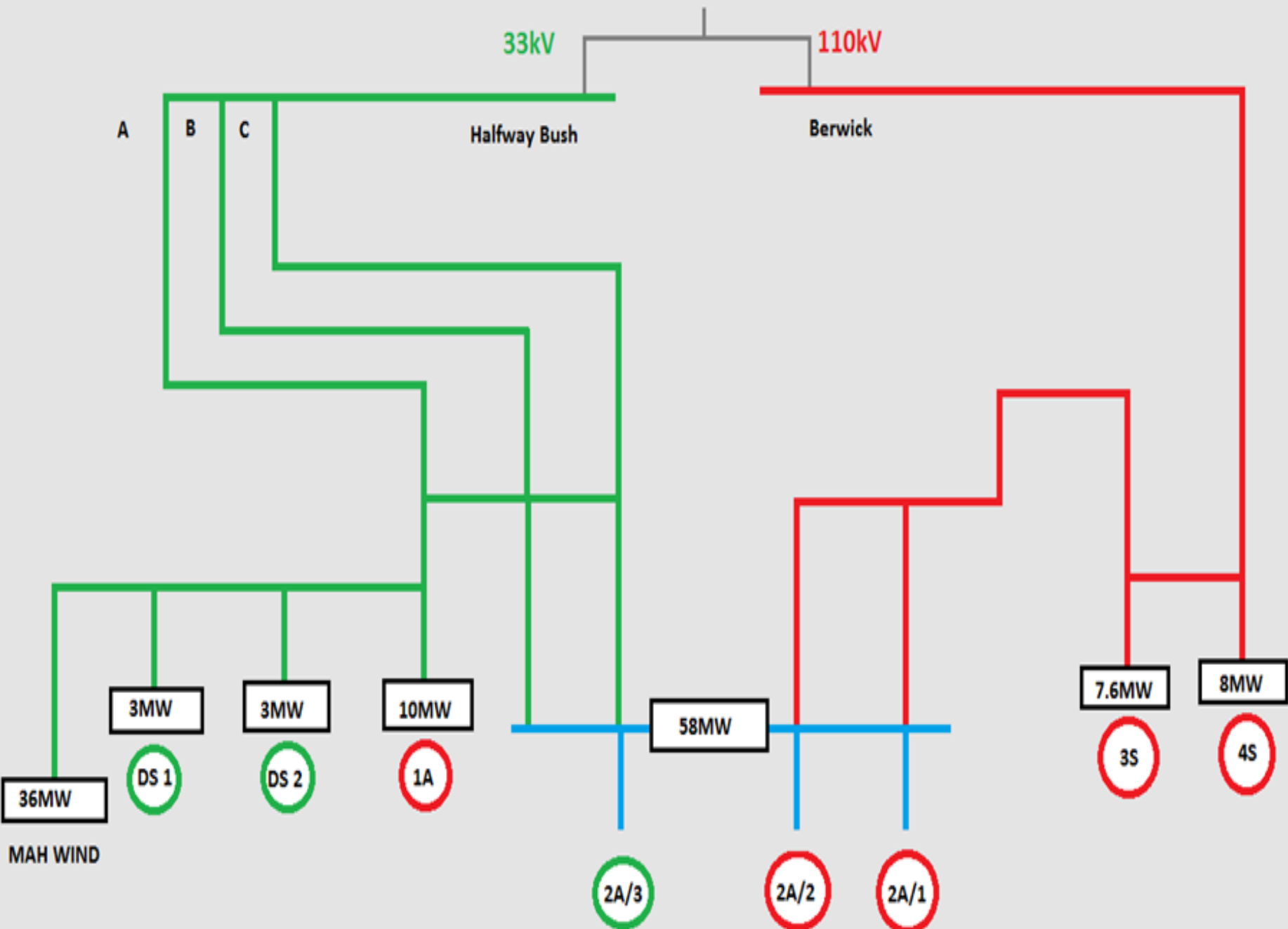

# Load profile for 80MW hydro capacity and 40MW of wind capacity

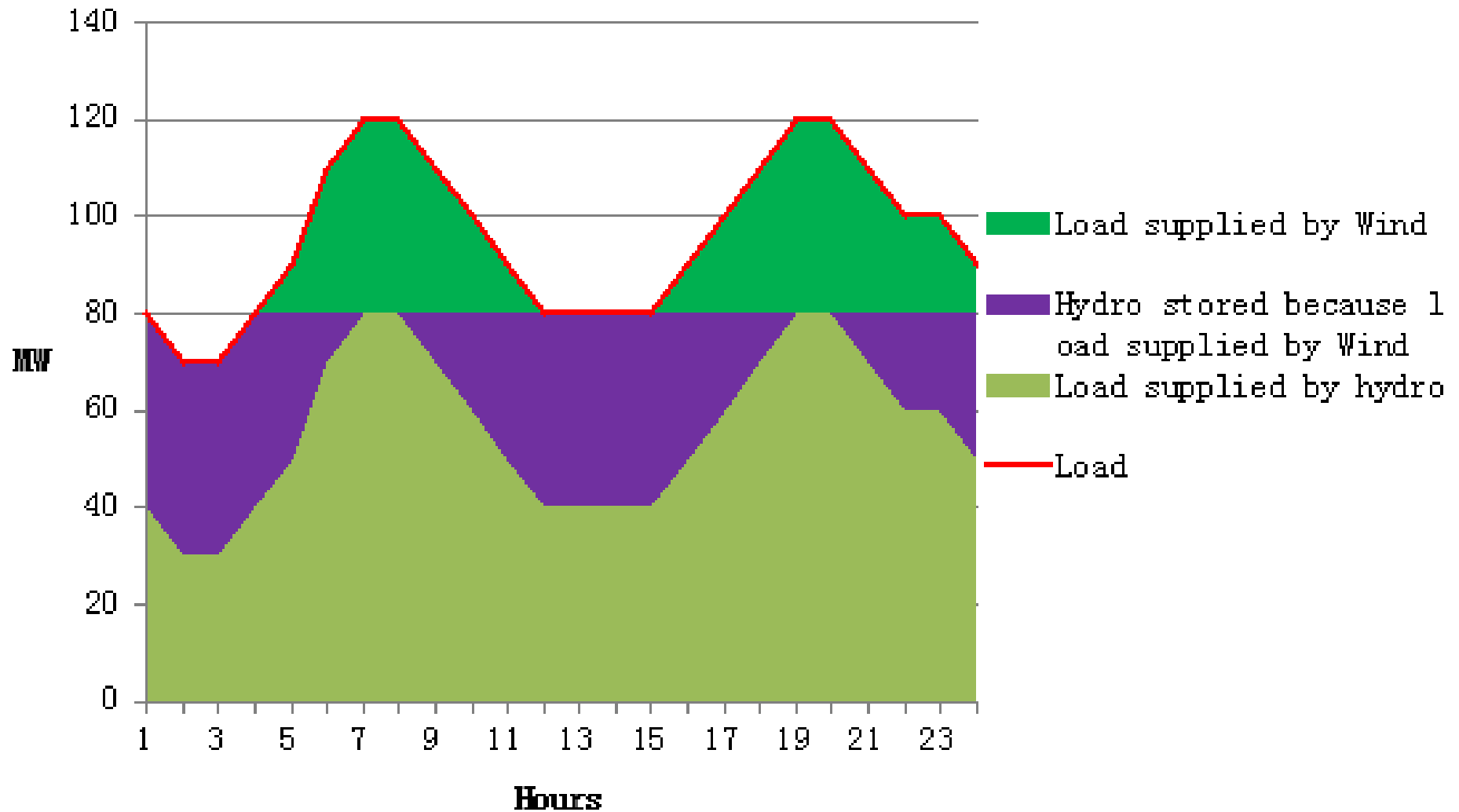

# Peaking Factors for WAI & DST

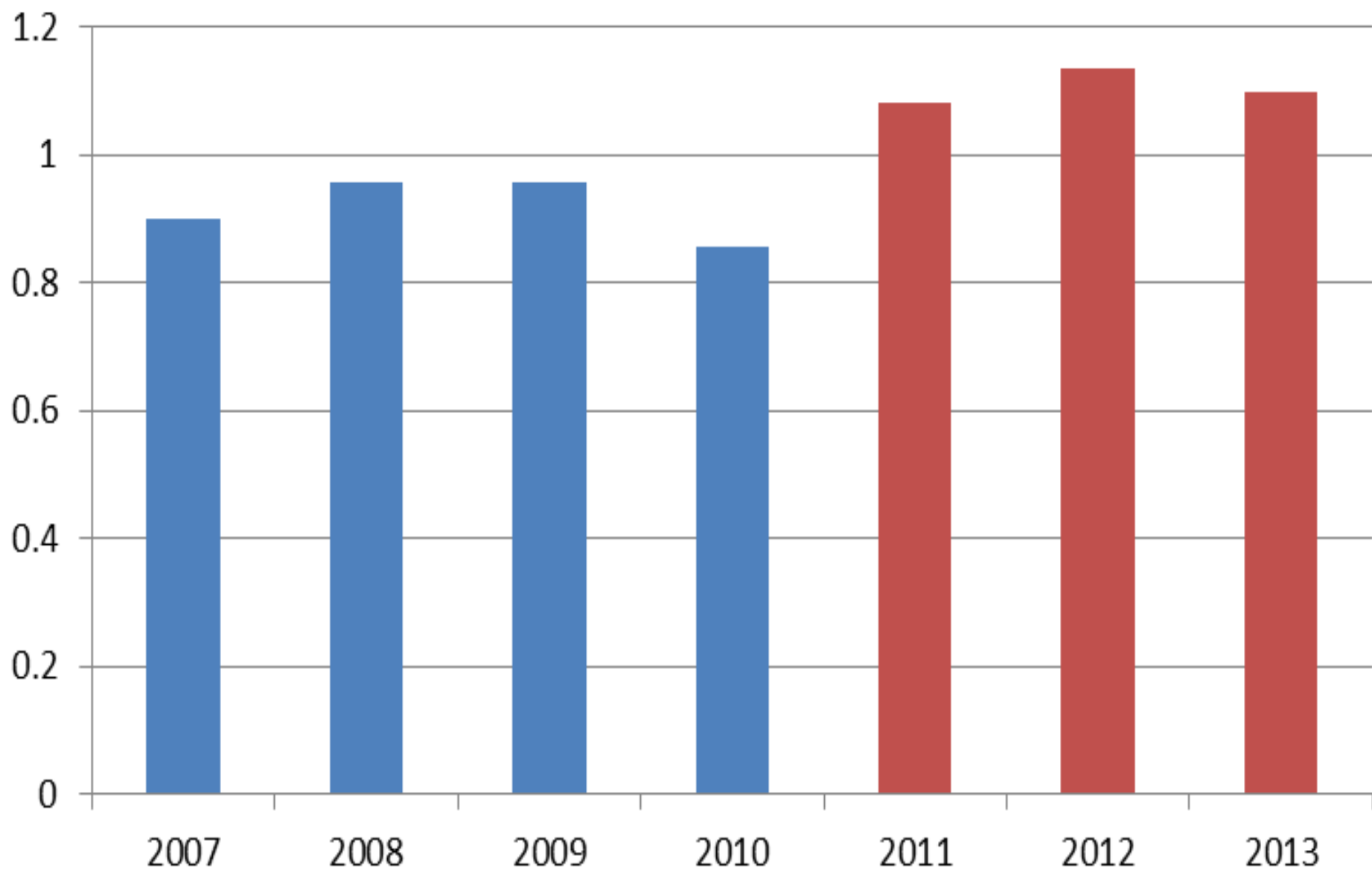

# So what does it mean for irrigation?





# Wind and Water – Better Together